

Installation guide

Pressure switch

Types KP 1 and KP 7W



060R9760

060R9760

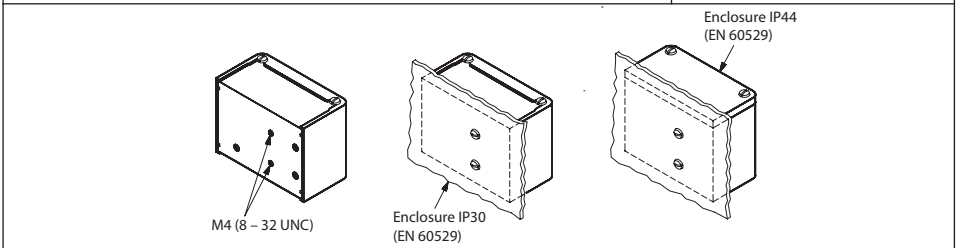
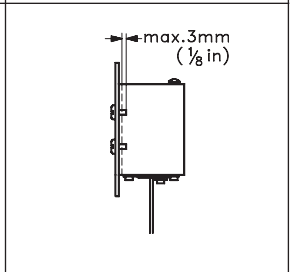
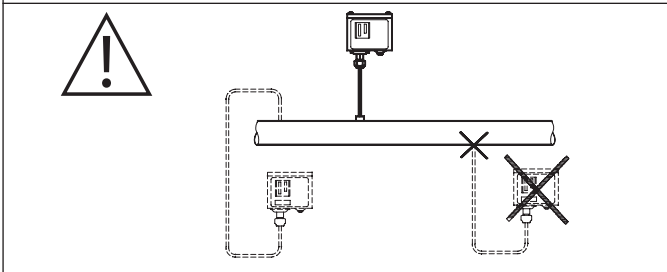
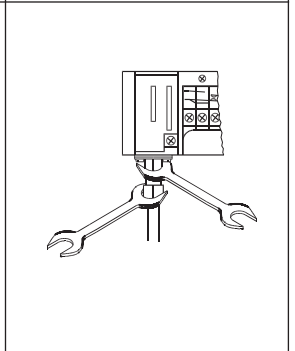
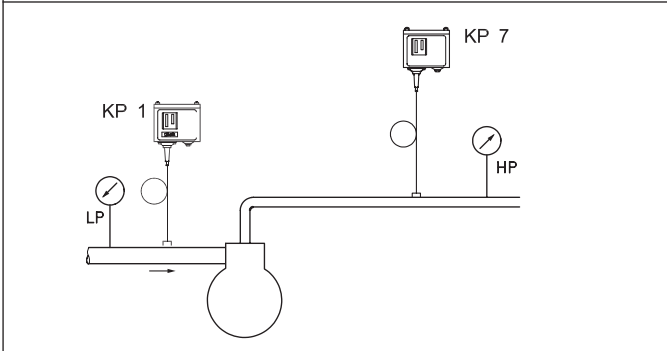
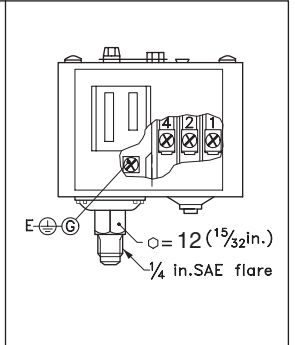
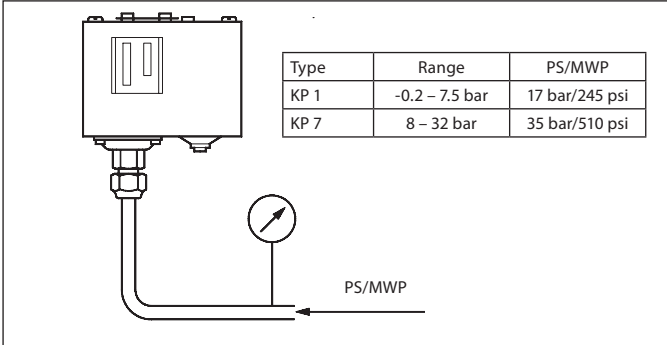



CAUTION:

Disconnect power supply before wiring connections are made or service to avoid possible electrical shock or damage to equipment.
Do never touch live parts with your fingers or with any tool.

KP 1

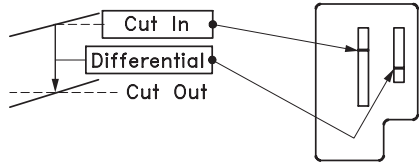
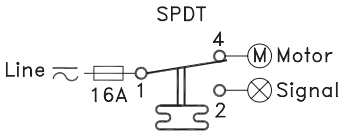

KP 7

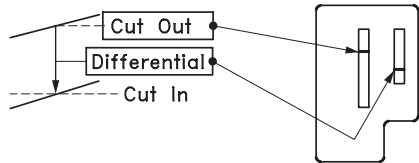
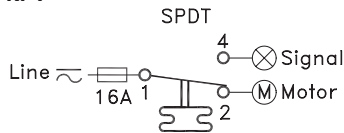

Manual trip function

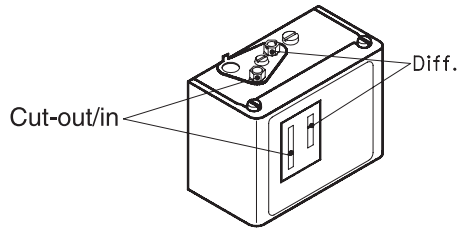
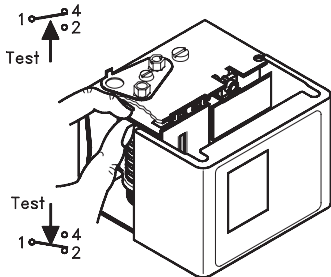

Electrical rating - General

LR 112A	AC 1: 16A	400 V	DC 11
	AC 3: 16A		12 W
	AC 15: 10 A		220 V

When used acc. to UL regulations



Listed refrigeration controller 61B5

Voltage	FL	LR	Resist. load	Pilot duty
240 AC	A	A	8 A	3 A
120 AC	8	48	16 A	
120 AC	16	96	16 A	12 W
240 AC				

Use copper wire only
Tightening torque 20 lb.in.

